

REF.
MANUAL
WE00103

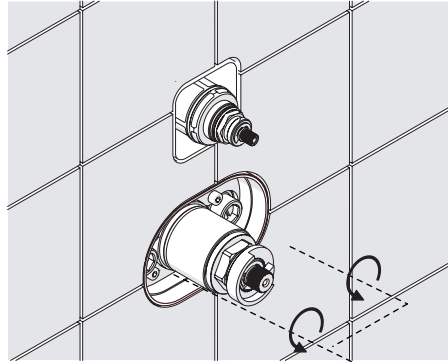

3

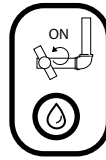
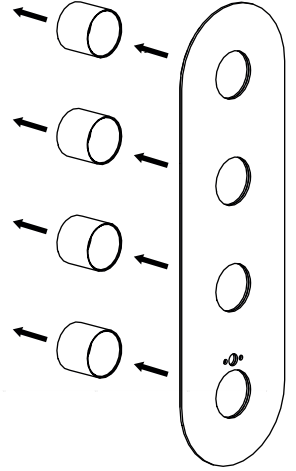
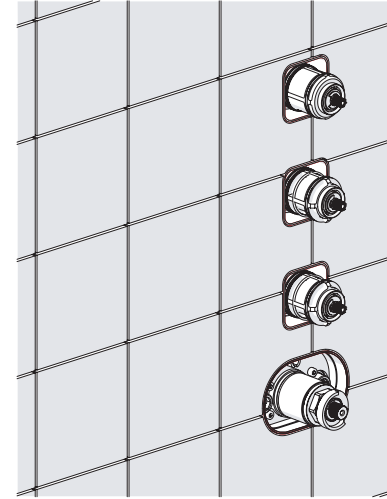

5

Not included / Non incluso / Non Inclus / Nie zawarty / No incluido / Nao incluido



2

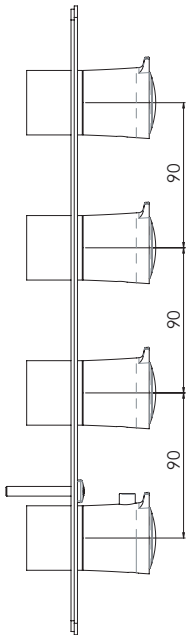
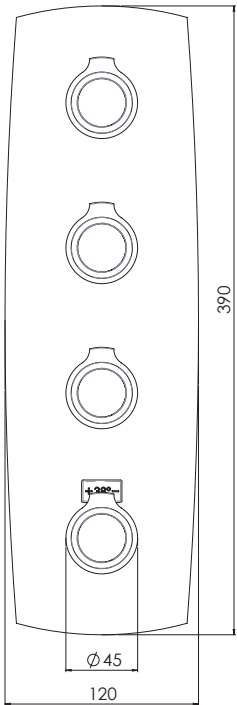

4

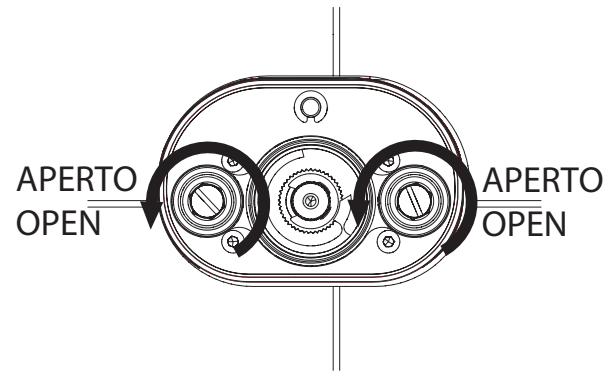

6

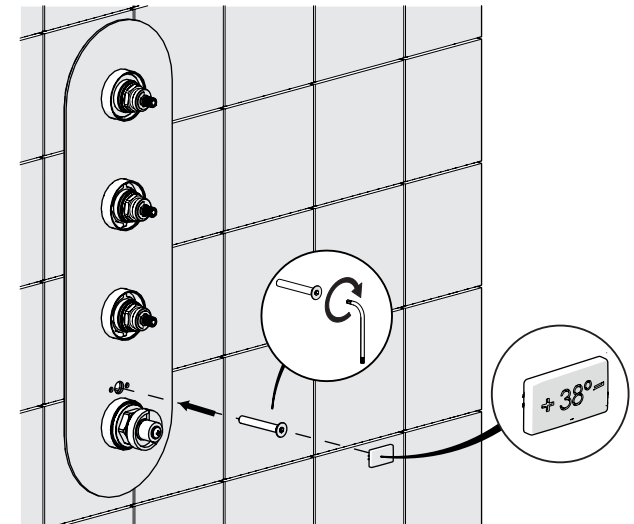

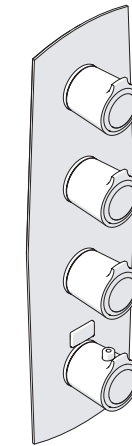

SF00103



www.grupponobili.it

PRIMA DI INIZIARE / BEFORE STARTING

	P	P	MAX 10	5		T	T	MAX 80	65	45
	bar	0,5	MIN	1		°C	°C			

PULIZIA / CLEANING

ACQUA WATER	ALCOOL	MICROFIBRA MICROFIBER	SPUGNA SPONGE	DETERGENTI DETERGENT

7

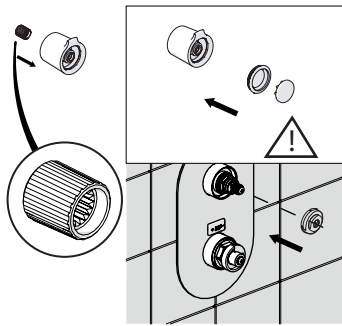

POSIZIONARE LA MANIGLIA CON CARTUCCIA CHIUSA COME IN FIGURA
POSITION THE HANDLE WITH CLOSED CARTRIDGE AS SHOWN

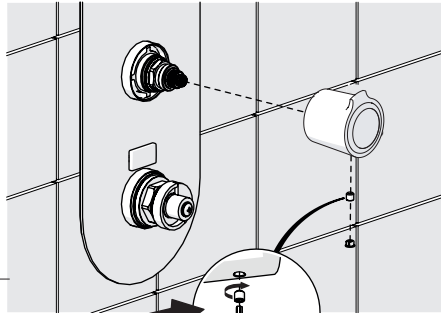

NON FORZARE TROPPO
DO NOT FORCE TOO

8

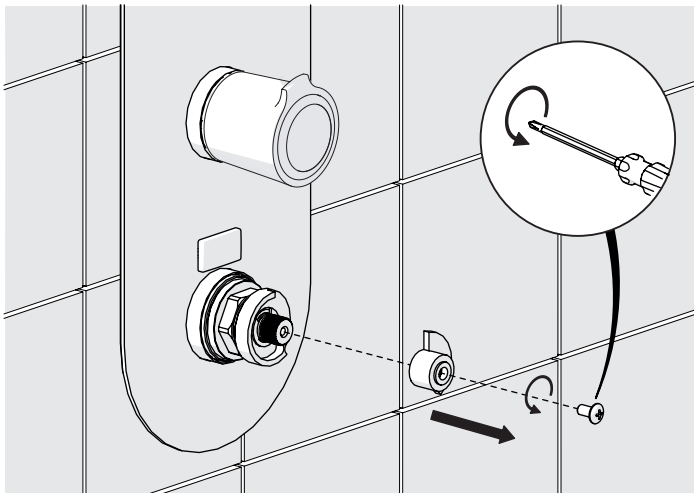

9

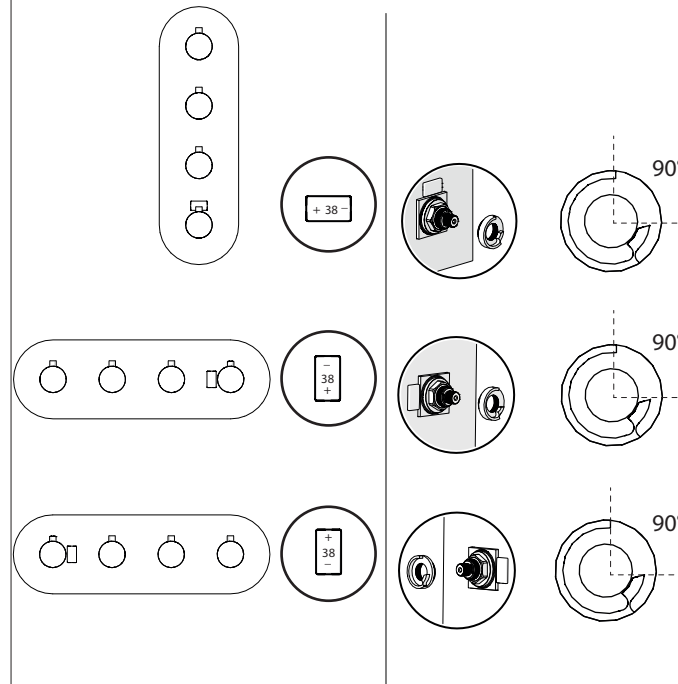

10

